

Ventilation Equipment
430 S/S Wall Hood+Filters
3600X1400mm

ITEM # _____

MODEL # _____

NAME # _____

SIS # _____

AIA # _____



642163 (BP1436BT)

430 stainless steel Wall Hood with filters

Short Form Specification

Item No. _____

Constructed in 430 AISI stainless steel. Equipped with labyrinth filters in 430 AISI stainless steel, blind panels in 304 AISI stainless steel, grease collecting trough all around and condensate collecting tray.

Main Features

- External panels with upturned edges to avoid injuries.
- Prearranged for installation of lighting.
- Low noise level.

Construction

- Eyebolts and screw anchors for ceiling installation.
- 430 AISI stainless steel labyrinth filters easily removable for cleaning.
- 304 AISI stainless steel condensation collection tray.
- Labyrinth filters guarantee constant filtration to avoid clogging and to protect against fire.
- 304 AISI stainless steel blind panels for a correct exhaustion.
- Outlet holes are sized in order to minimize drops in pressure.
- Perimetral gutter with drain hole to transfer grease into a 304 AISI container.
- Entirely constructed in 304 AISI stainless steel.

Optional Accessories

- Drain for hoods, diam.1/2" (m), PNC 640409 with plug
- Speed variator for motors up to 1,7 kW PNC 640686

APPROVAL: _____

Front



Key Information:

External dimensions, Width:	
642163 (BP1436BT)	3600 mm
External dimensions, Depth:	1400 mm
External dimensions, Height:	500 mm
Net weight:	92 kg

Air Emission:

Air capacity:	6600 mc/h
---------------	-----------

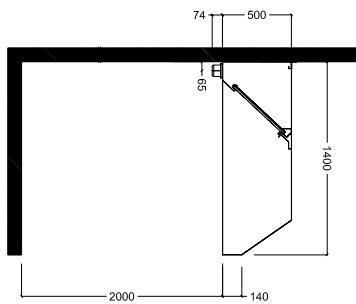
Side



Top

